







 Ø6,3x50 mm <b>A1 x 30</b>	 Ø12 mm <b>A2 x 30</b>	 4 mm <b>A3 x 1</b>	 Ø15x12 mm <b>B1 x 8</b>	 Ø5x44 mm <b>B2 x 8</b>
 Ø20 mm <b>B3 x 8</b>	 Ø4x16 mm <b>D1 x 16</b>	 Ø3x25 mm <b>D2 x 8</b>	 Ø1,6x25 mm <b>F x 68</b>	 Ø8x36 mm <b>G x 16</b>
 <b>M x 4</b>	 Ø15 mm <b>N x 8</b>	 <b>Z x 8</b>		

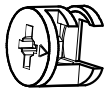
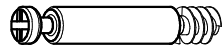

### Box 1 / 2

1400x400x16 mm

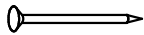
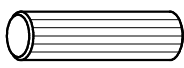
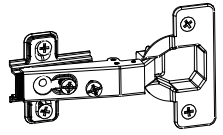
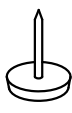

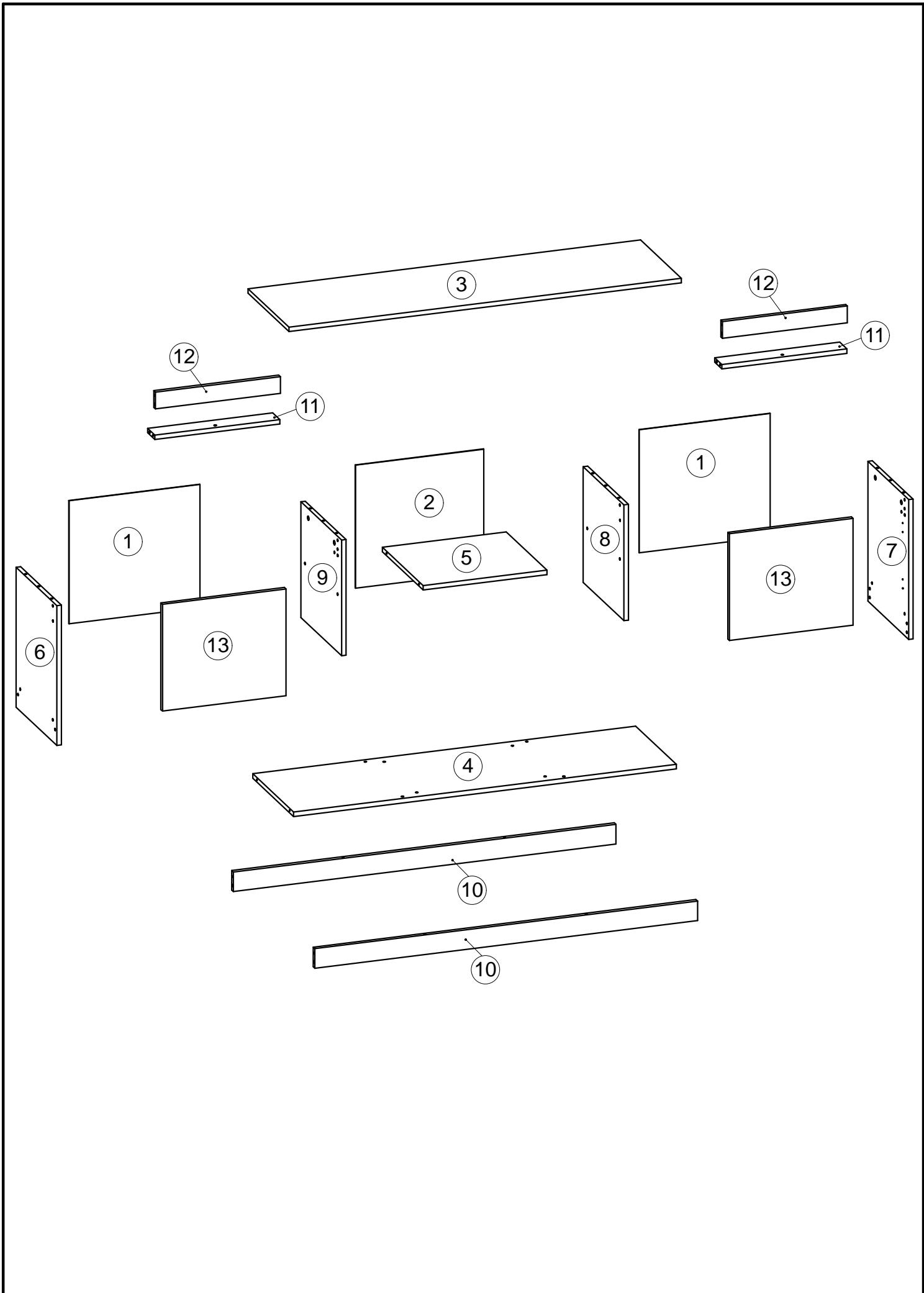
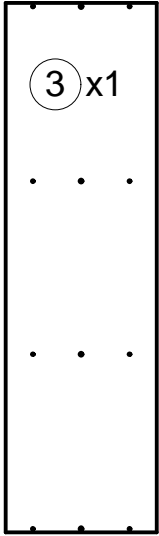
1366x399x16 mm



442x399x16 mm

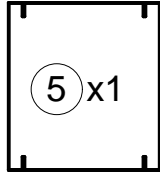

499x399x16 mm

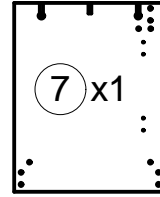

1366x70x16 mm

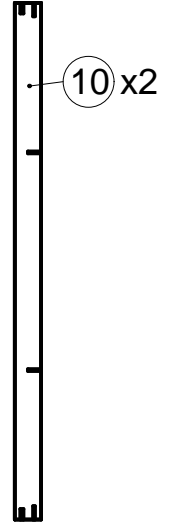

499x399x16 mm

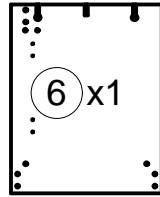

413x399x16 mm

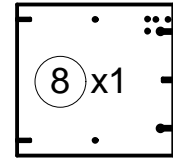

413x399x16 mm

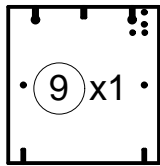

446x70x16 mm

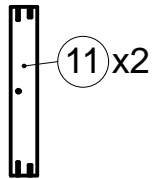

446x60x16 mm

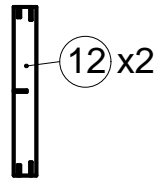

Fittings & Tools

### Box 2 / 2

467x439x3 mm

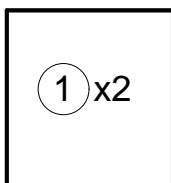

458x439x3 mm

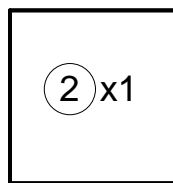

440x380x16 mm

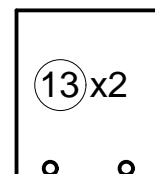

1

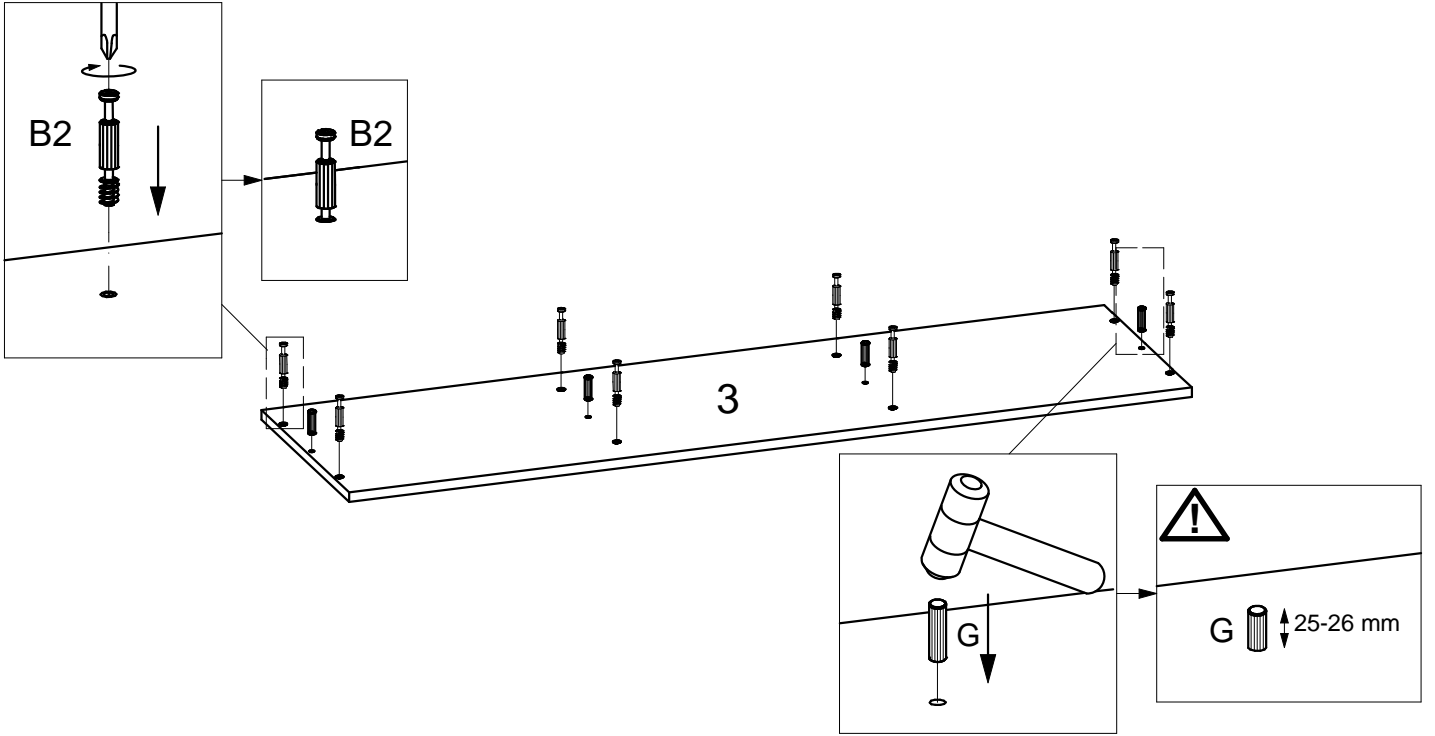
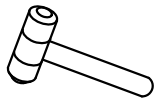
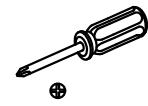
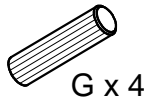
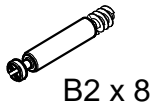

2

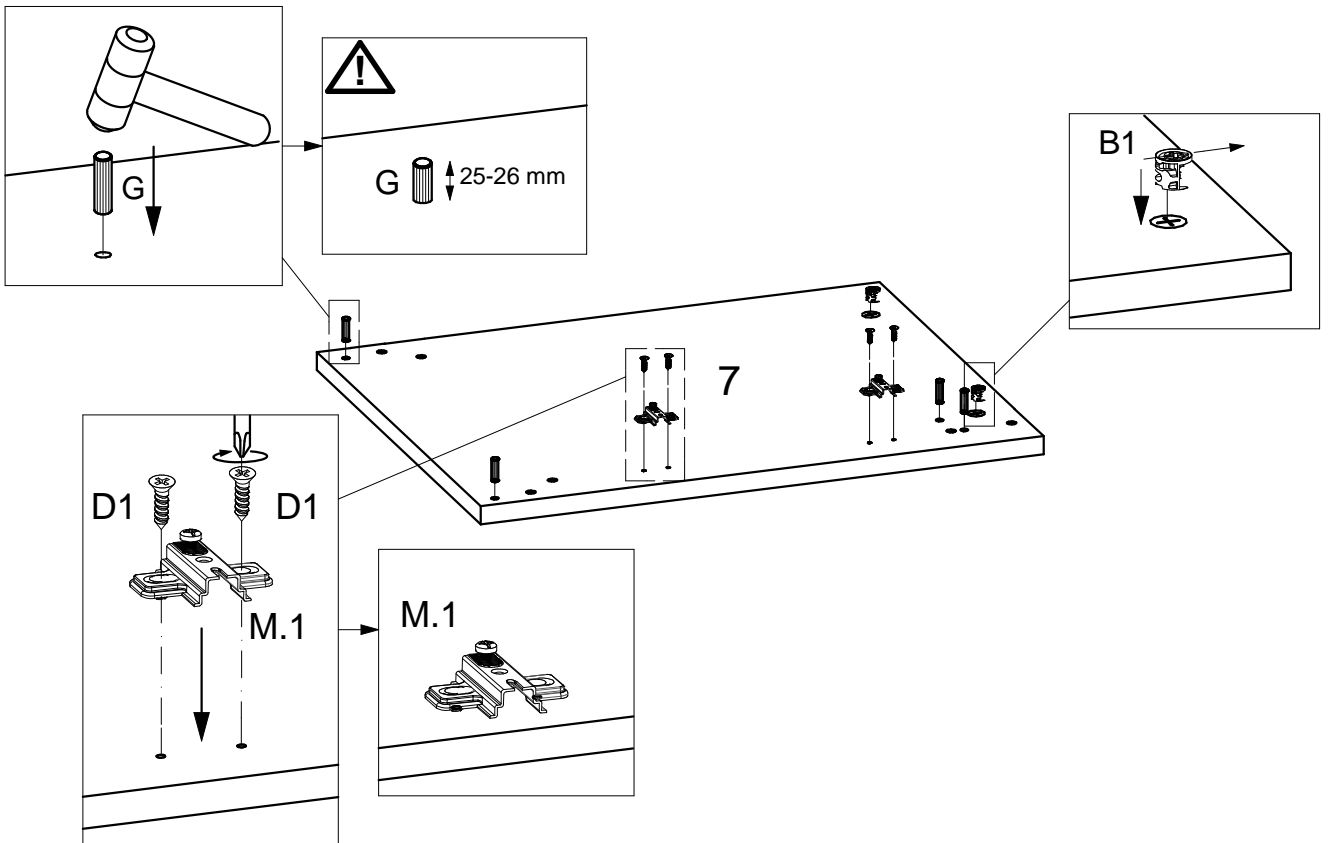
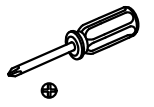
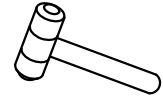

3



B1 x 2



G x 2

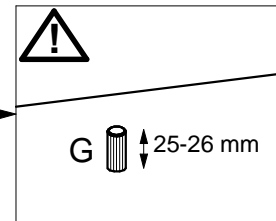
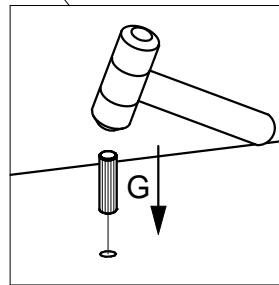
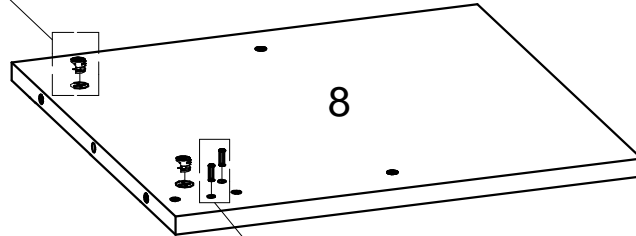
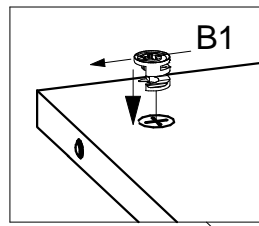
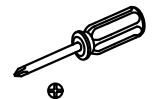
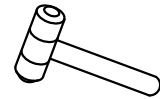

4



B1 x 2



G x 2

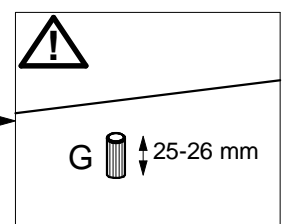
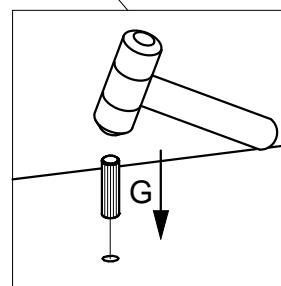
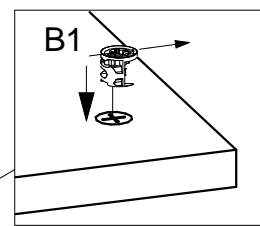
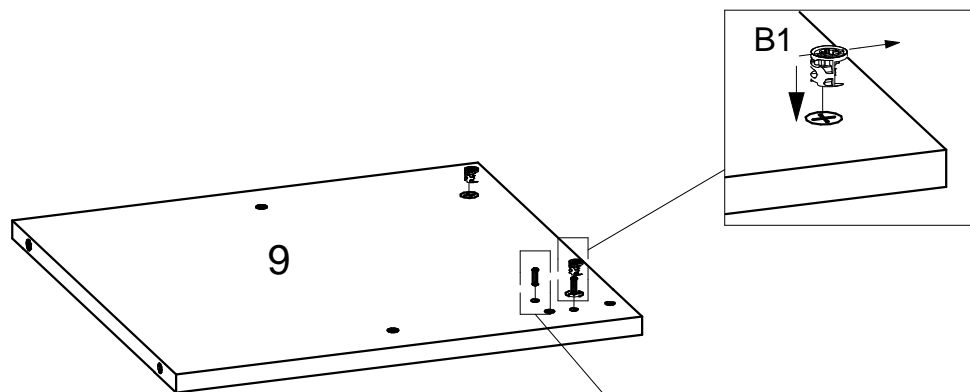
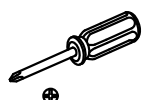
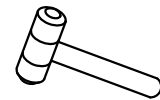

5

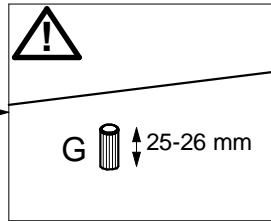
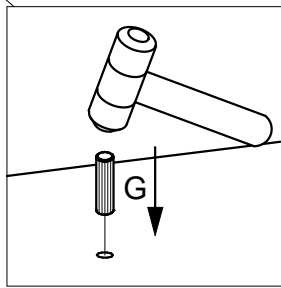
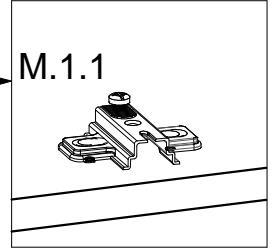
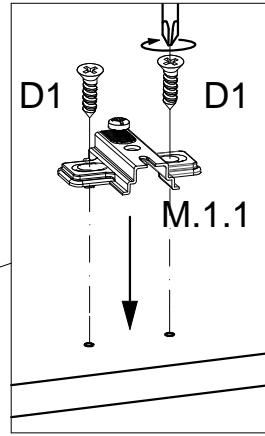
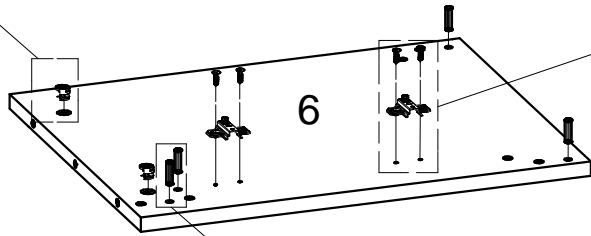
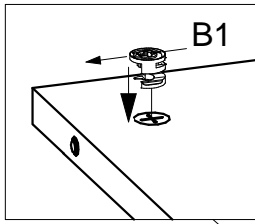
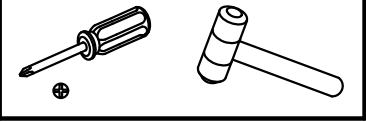
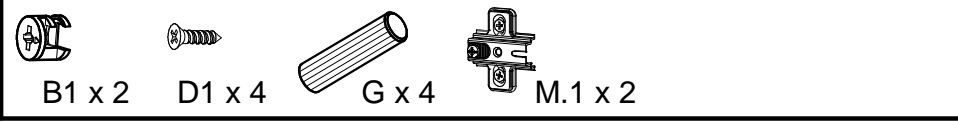

6

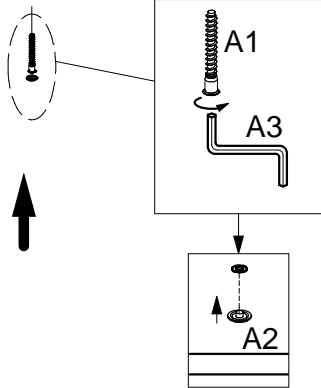
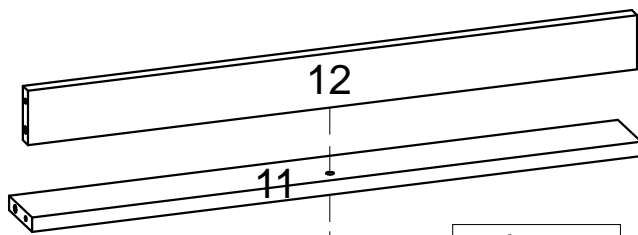
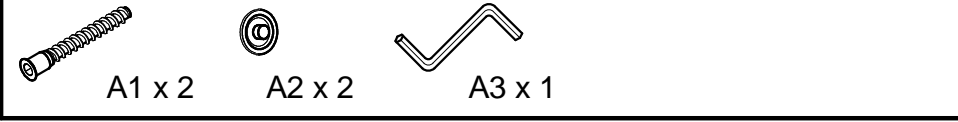

x 2



7



A1 x 4



A2 x 4



A3 x 1

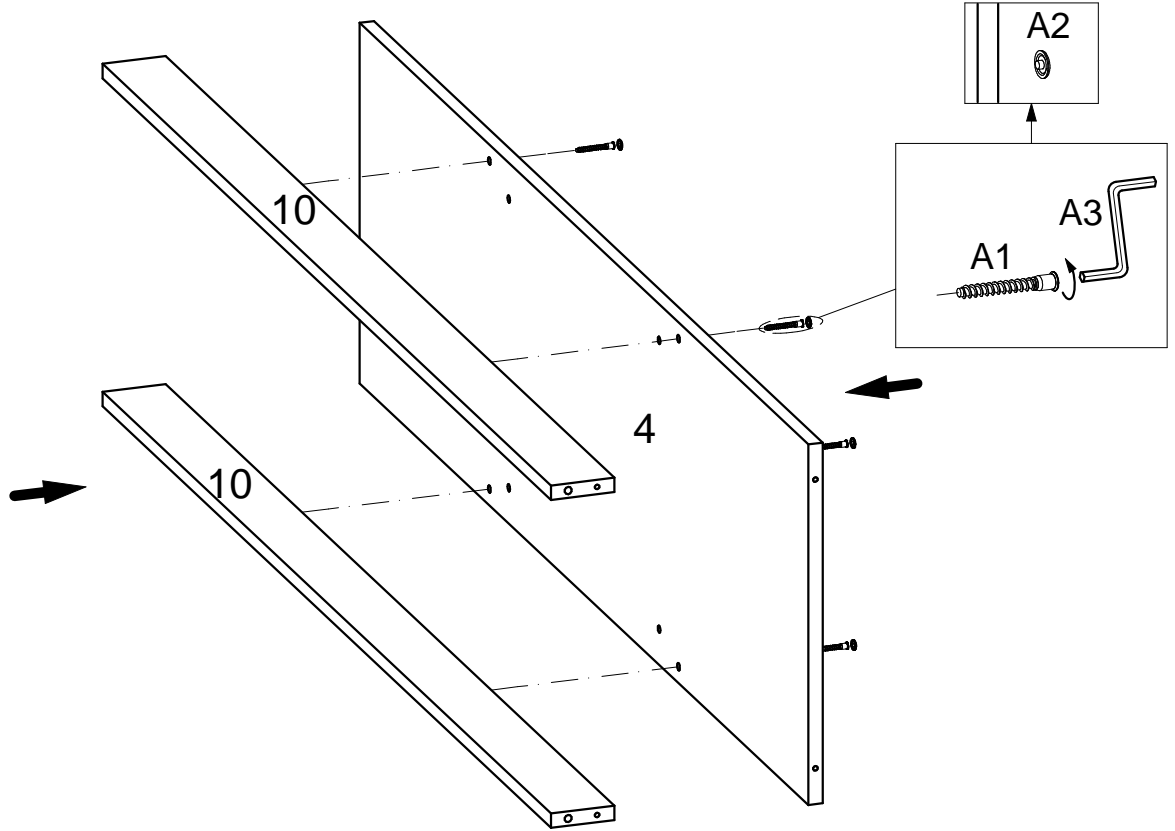

8

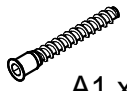

A1 x 4



A2 x 4



A3 x 1

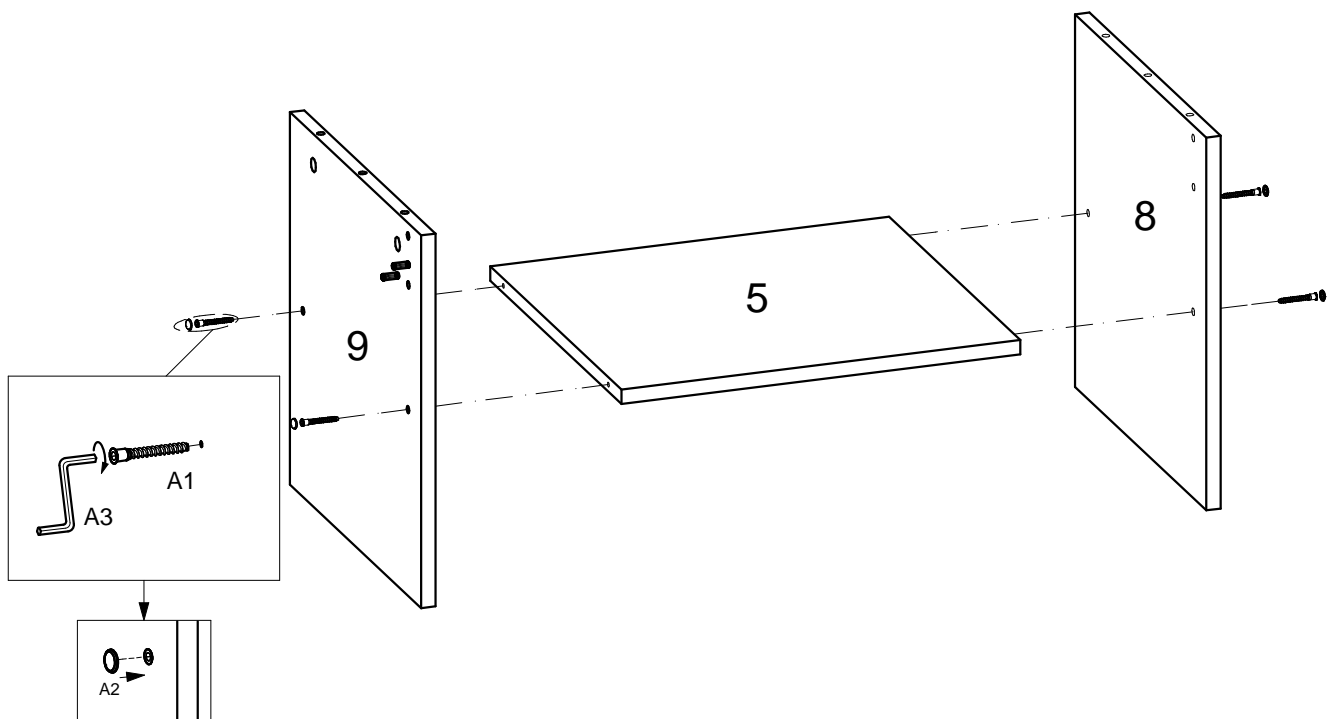

9

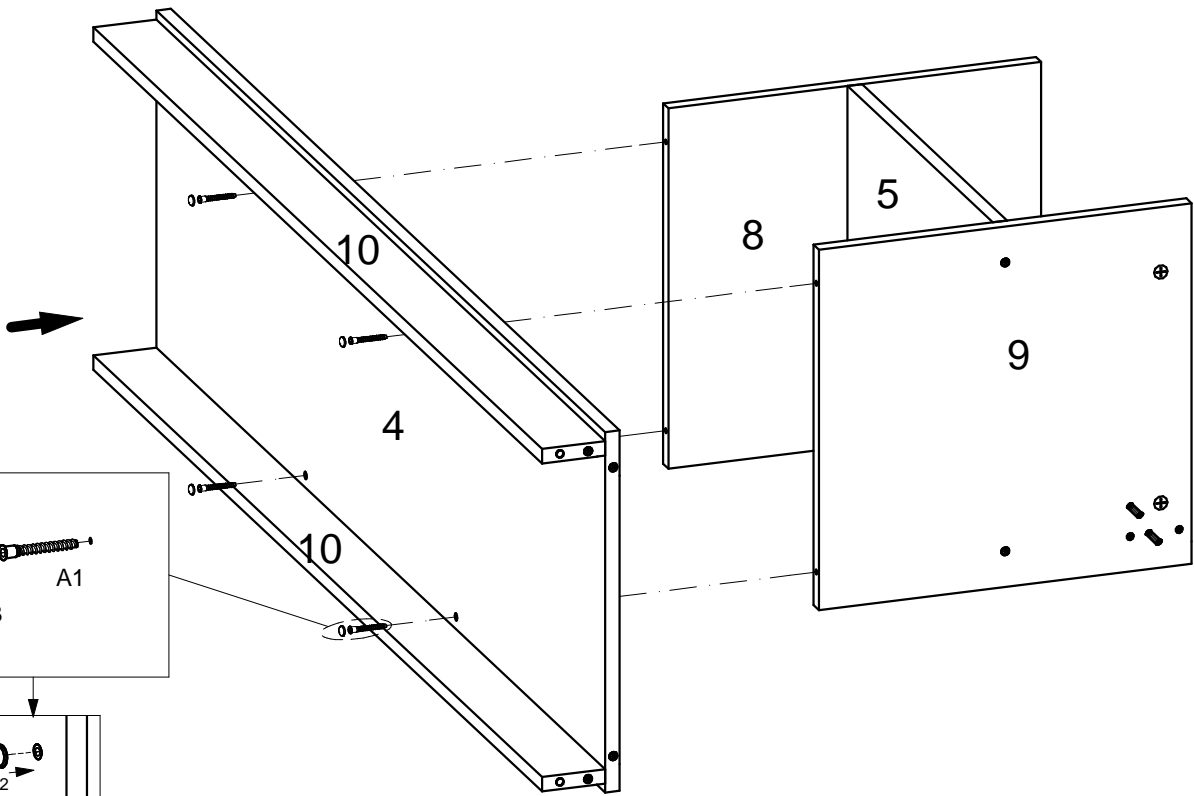
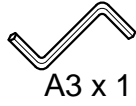
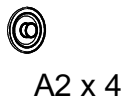
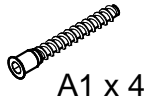

10

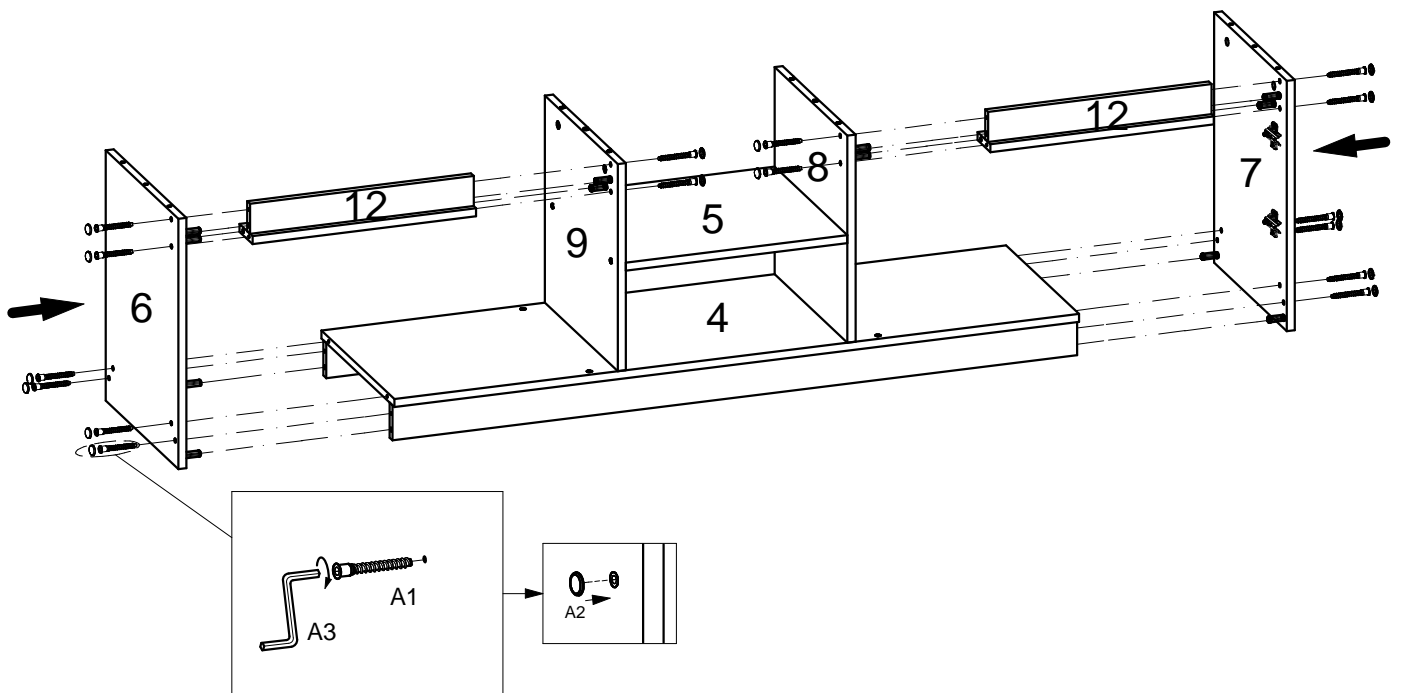
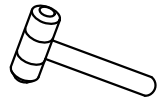
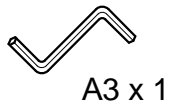
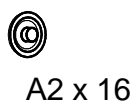
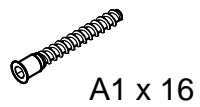

11



B3 x 8

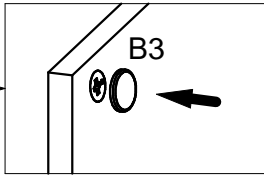
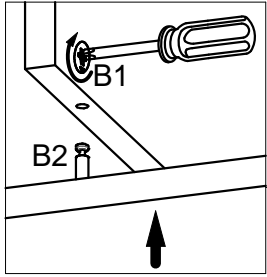
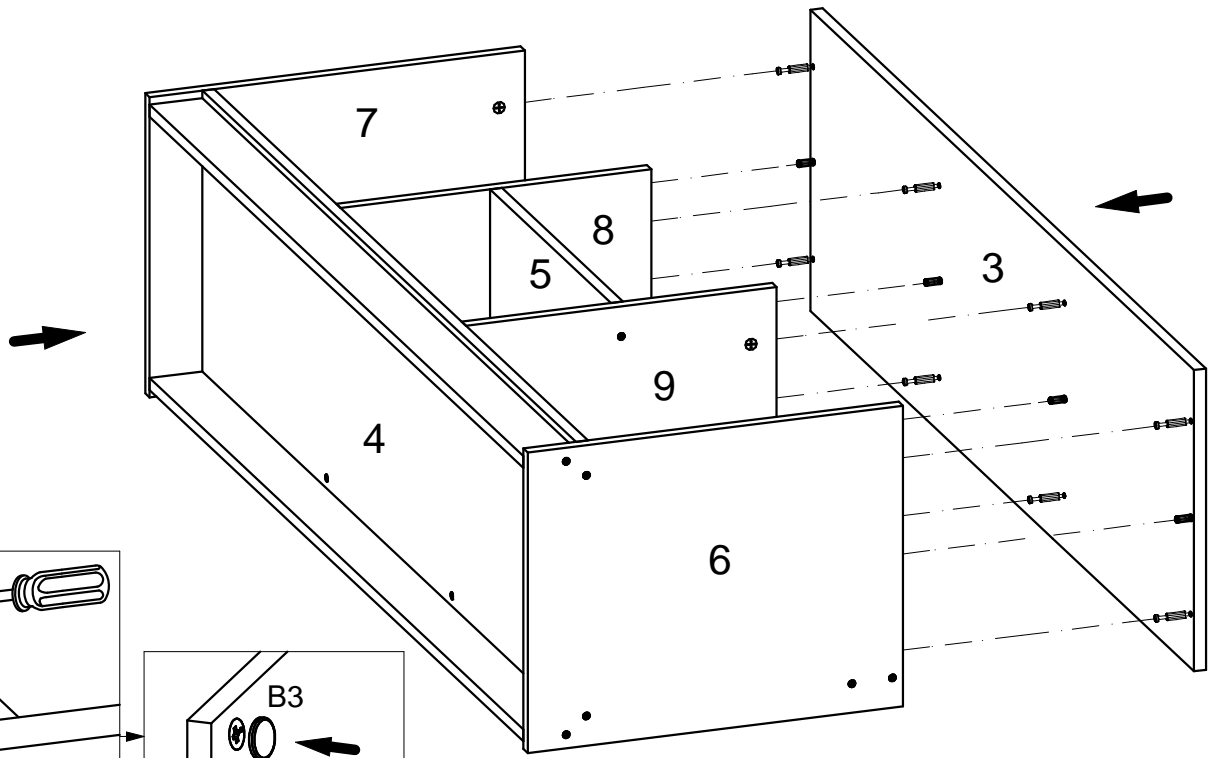
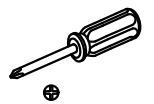
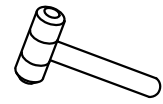

12



D2 x 8

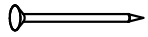

F x 68



N x 8



C x 8

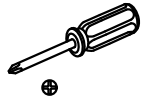
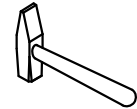

**!**  $XX=YY \cong 90^\circ$

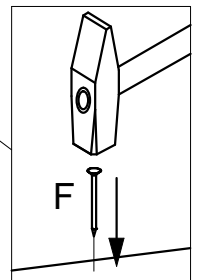
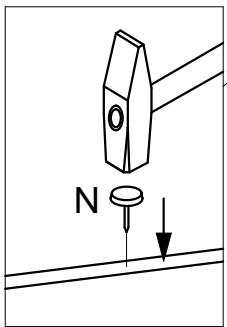
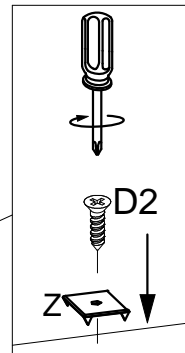
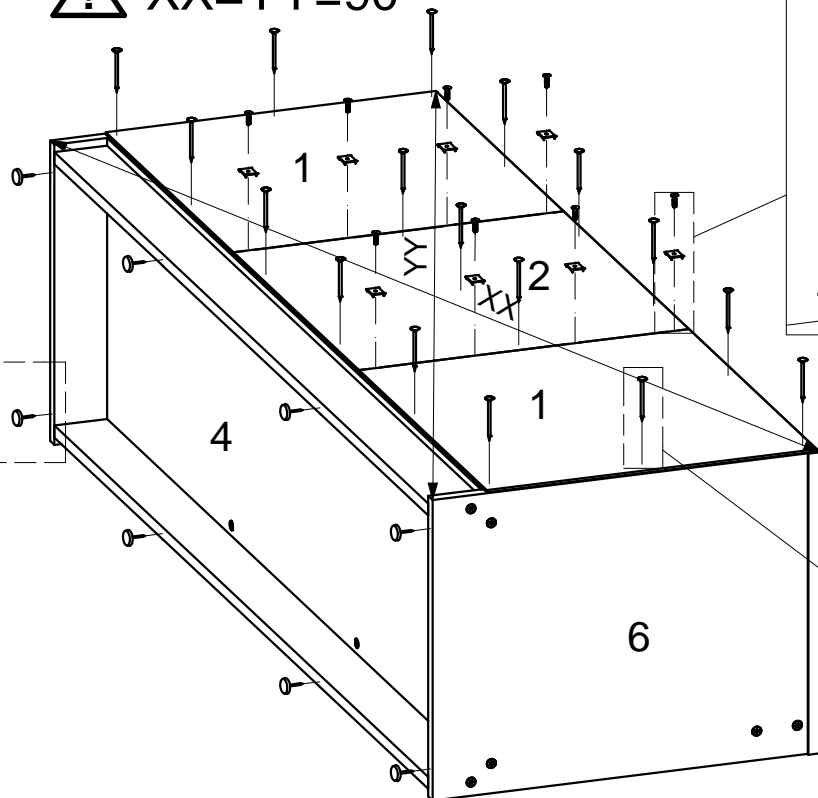

13



D1 x 8

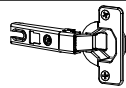

M.2 x 4

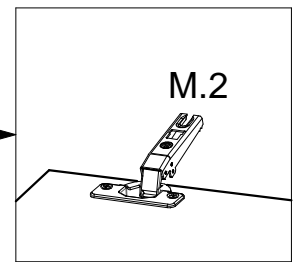
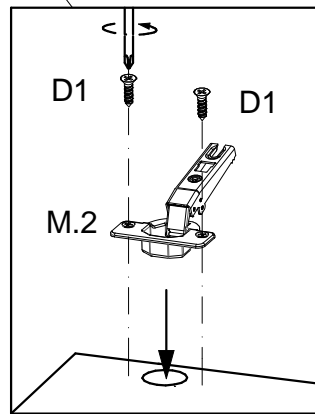
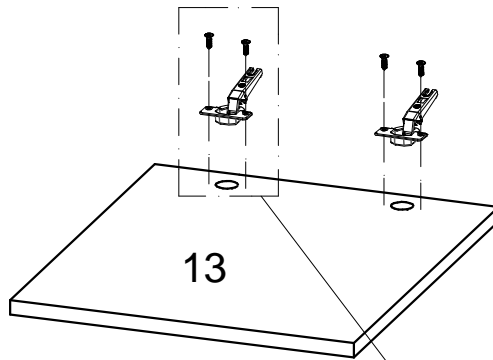
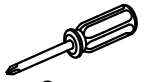

x 2

14

